

Project: _____	AIA# _____
Item #: _____ Qty: _____	SIS# _____
Model #: _____	

Soiled Dish Table

Product Information



TAB-SD
 30" D by 66" L straight, left, Soiled Dish Table with 20" by 20" by 6" deep pre-rinse sink with removable scrap basket

Glastender highly configurable Soiled Dish Tables deliver tailor-made solutions. All stainless steel, TIG welded construction.

Top options include:

- Side - left or right
- Style - straight, island, corner, landing, or U-landing
- Endsplash - none, left, or right
- Tubular overshelves
- Disposer cutouts
- Scrap basket
- Scrap block
- Notching to fit dishwasher models

Base options include:

- Undershelf - none, welded, or adjustable
- Legs - welded or knock down
- Feet - bullet or flanged



Intertek

4004503
 Conforms to ANSI/NSF STD 2

Specifications

NOTE: Due to the highly configurable nature of Glastender Soiled Dish Tables, some of the specifications below only apply if those options are selected.

Drain

- 3-1/2" centered drain hole or to fit customer supplied disposer collar

Faucets

- Faucet holes: Splash mount, 1-1/8" diameter, 4" or 8" centers

Legs

- 1-5/8" diameter, 16 gauge stainless steel

Cross members

- 1-1/4" diameter, 16ga stainless steel

Feet

- Stainless steel bullet or stainless steel flanged

Materials

- Top: 14 gauge type 304 stainless steel or 16 gauge type 304 stainless steel
- Sink bowl: 14 gauge type 304 stainless steel or 16 gauge type 304 stainless steel
- Support channels: 14 gauge type 201 stainless steel
- Undershelf adjustable sockets: cast aluminum

To view cleaning and care instructions, please visit:
http://www.glastender.com/PDF/F-423-011_ss_clean_care.pdf

Glastender, Inc. • 5400 N Michigan Rd • Saginaw, MI • 48604-9780 989.752.4275 • 800.748.0423 • Fax 989.752.4444 www.glastender.com	Approval/Notes:
Specifications subject to change without notice. For current specifications please visit our website.	

Soiled Dish Tables

Dimensional Information

PLAN VIEWS

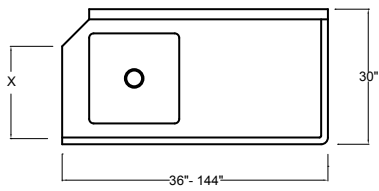

Straight

X = Dimension determined per dishwasher specification

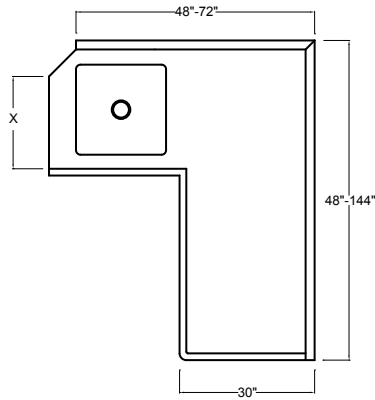

L Shape Corner

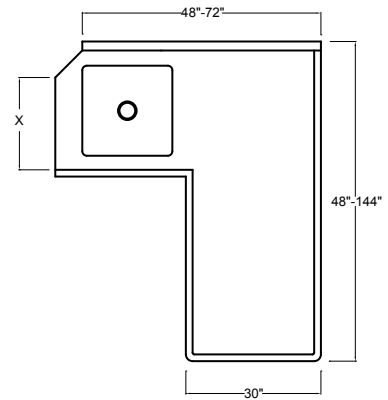

L Shape Island

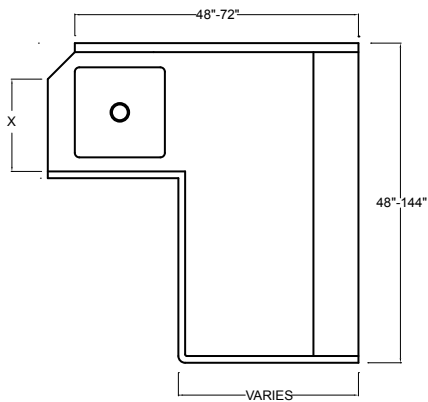

L Shape with Landing

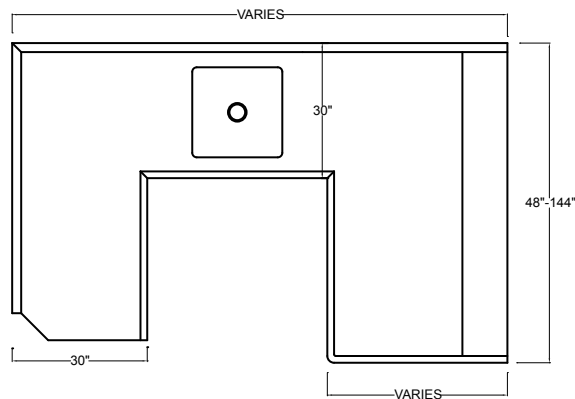

U Shape Landing

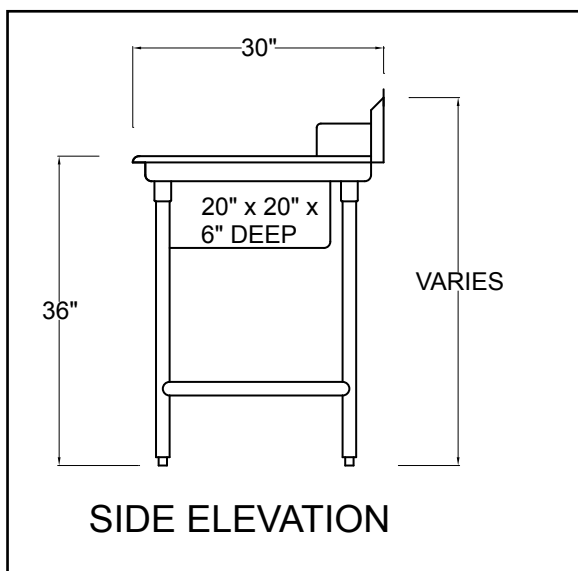

SIDE ELEVATION

Backsplash and Endsplash Details

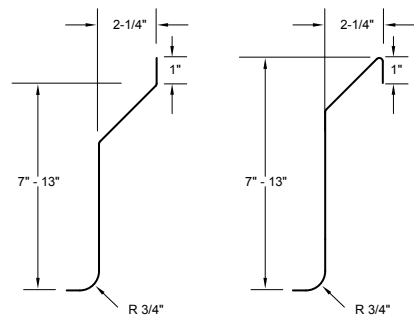

Upturn Option

Downturn Option