

Decorative Beer Towers

Hand Crafted Ceramic Towers



Body Style:
(2 or 3 faucets)
RB = Rembrant
BF = Black Forest
(2, 3, or 4 faucets)
VN = Vienna
BM = Braumeister
(5, 6, or 8 faucets)
VE = Vienna Ellipse
BE = Braumeister Ellipse

Create a model number by selecting from the options:

T- - - -

Number of Faucets
2 = Two faucets (VE & BE only)
3 = Three faucets (VN & BM only)
4 = Four faucets
5 = Five faucets
6 = Six faucets
8 = Eight faucets

Hardware:
MF = Chrome
PB = Brass

Color:
01 = Clear (white)
04 = Federal Blue
05 = Corporate Blue
07 = Midnight Blue
08 = Emerald Green
11 = Hunter Green
13 = Black
17 = Strawberry Red

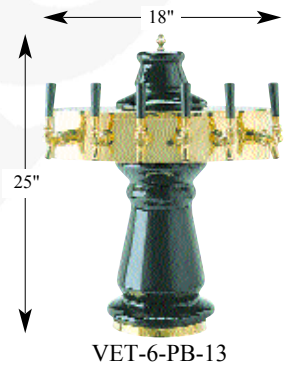

Zeus Ceramic Towers

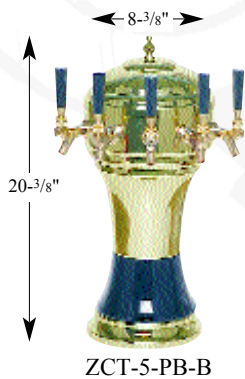

Create a model number by selecting from the options:

ZCT- - - -

No. of Faucets
3 = Three faucets
4 = Four faucets
5 = Five faucets

Hardware:
MF = Chrome
PB = Brass

Color:
G = Green
W = White
B = Black



Mushroom Towers

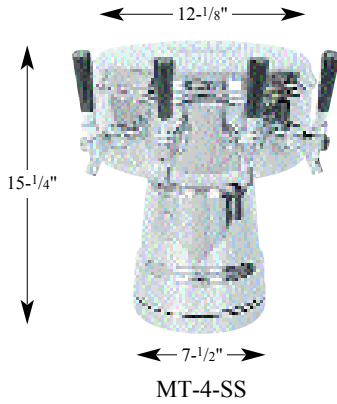

Create a model number by selecting from the options:

MT- - -

No. of Faucets
 4 = Four faucets
 5 = Five faucets
 6 = Six faucets

Finish:
 SS = Stainless
 PB = Brass

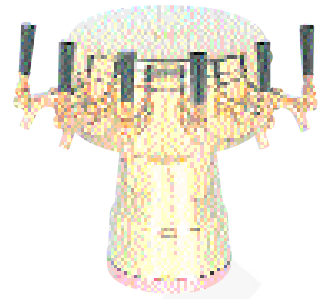

MT-6-PB

Mini Mushroom Towers

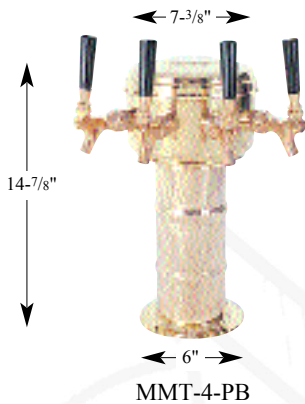

Create a model number by selecting from the options:

MMT- - -

No. of Faucets
 3 = Three faucets
 4 = Four faucets

Finish:
 SS = Stainless
 PB = Brass

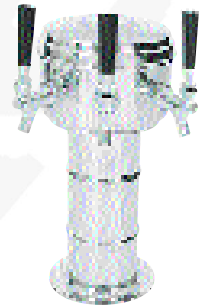

MMT-3-SS

Tube Towers

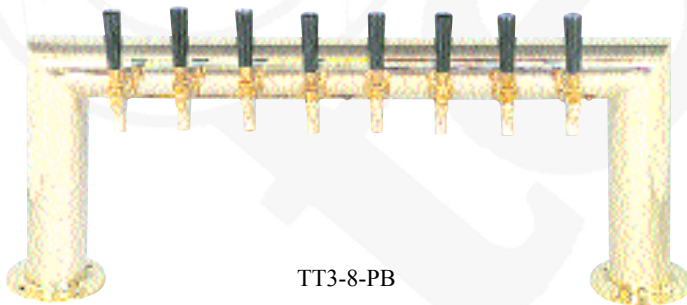

Create a model number by selecting from the options:

TT - - -

Tube:
 4=4"

No. of Faucets
 8 = Eight faucets
 10 = Ten faucets
 12 = Twelve faucets

Finish:
 SS = Stainless
 PB = Brass

Dimensional Information (based on tube size and number of faucets):

3" models: No Longer Available

4" models: 14" high, length = 33" (8), 39" (10), or 45" (12)